



# Spring Clamp Terminal Blocks



## Products

IMAGE	PART NUMBER	PROPERTIES	FEATURE	PAGE NUMBER MAIN CATALOG
	ST061xxHDNN *(AST061)	 130 V / 10 A / 28–20  130 V / 6 A / 0.5 mm <sup>2</sup>	   	23
	ST021xxHDNN *(AST021)	 150 V / 8 A / 28–20  130 V / 6 A / 0.5 mm <sup>2</sup>	   	23
	ST041xxDDNN *(AST041)	 150 V / 8 A / 28–18  130 V / 6 A / 0.5 mm <sup>2</sup>	   	24
	ST072xxHGNN *(AST072)	 150 V / 6 A / 26–20  130 V / 6 A / 0.5 mm <sup>2</sup>	   	25
	ST072xxVGNN *(AST082)	 150 V / 6 A / 26–20  130 V / 6 A / 0.5 mm <sup>2</sup>	   	25
	SR213xxHBNC *(AST223)	 150 V / 10 A / 28–16  130 V / 17.5 A / 1.5 mm <sup>2</sup>	     	26
	SR213xxHBPC	150 V / 10 A / 28–16  130 V / 17.5 A / 1.5 mm <sup>2</sup>	     	26
	SR213xxDBNC *(AST233)	 150 V / 10 A / 28–16  130 V / 17.5 A / 1.5 mm <sup>2</sup>	     	27
	SR213xxDBPC	 130 V / 10 A / 28–16  130 V / 17.5 A / 1.5 mm <sup>2</sup>	     	27
	SR213xxVBNC *(AST213)	 150 V / 10 A / 28–16  130 V / 17.5 A / 1.5 mm <sup>2</sup>	     	28
	SR213xxVBPC	 150 V / 10 A / 28–16  130 V / 17.5 A / 1.5 mm <sup>2</sup>	     	28

 Spring clamp terminal block

 Solderable

 Designed for THR

 Wire entry 90°

 Wire protector

 Wire entry 0°

 Approval pending

 Lift system

 Pluggable

 Designed for SMT

 Centerline

 Diagonal wire entry



 Tape & Reel possible

IMAGE	PART NUMBER	PROPERTIES	FEATURE	PAGE NUMBER MAIN CATALOG
	ST024xxHDNC *(AST024)	150 V / 7 A / 28–20 250 V / 6 A / 0.5 mm <sup>2</sup>		29
	SR215xxHBNC *(AST225)	300 V / 10 A / 28–16 250 V / 17.5 A / 1.5 mm <sup>2</sup>		30
	SR215xxHBPC	300 V / 10 A / 28–16 250 V / 17.5 A / 1.5 mm <sup>2</sup>		30
	SR255xxHBNC	300 V / 18 A / 24–12 250 V / 9 A / 0.75 mm <sup>2</sup>		-
	ST065xxHDNN *(AST065)	300 V / 13 A / 28–14 250 V / 13.5 A / 1 mm <sup>2</sup>		31
	ST025xxHDNC *(AST025)	300 V / 13 A / 28–14 250 V / 13.5 A / 1 mm <sup>2</sup>		31
	ST055xxHBNC *(AST055)	300 V / 12 A / 28–12 250 V / 20 A / 2.5 mm <sup>2</sup>		32
	ST095xxHDNN *(AST095)	300 V / 15 A / 28–12 250 V / 13.5 A / 1 mm <sup>2</sup>		32
	SR215xxDBNC *(AST235)	300 V / 10 A / 28–16 250 V / 17.5 A / 1.5 mm <sup>2</sup>		33
	ST045xxDDNC *(AST045)	300 V / 13 A / 28–14 250 V / 13.5 A / 1 mm <sup>2</sup>		33
	ST255xxHBNL	300 V / 12 A / 24–12 250 V / 9 A / 0.75 mm <sup>2</sup>		-

## Products

IMAGE	PART NUMBER	PROPERTIES	FEATURE	PAGE NUMBER MAIN CATALOG
	ST255xxHBNR	300 V / 12 A / 24–12 250 V / 9 A / 0.75 mm <sup>2</sup>	   	-
	ST255xxHDNL	300 V / 12 A / 24–12 250 V / 9 A / 0.75 mm <sup>2</sup>	   	-
	ST255xxHDNR	 300 V / 12 A / 24–12 250 V / 9 A / 0.75 mm <sup>2</sup>	   	-
	ST135xxDDNC *(AST135)	 300 V / 13 A / 28–14 250 V / 24 A / 2.5 mm <sup>2</sup>	   	34
	ST175xxLDNN *(AST175)	 300 V / 15 A / 28–12 250 V / 13.5 A / 1 mm <sup>2</sup>	   	34
	ST185xxLDNN *(AST185)	 300 V / 15 A / 28–12 250 V / 13.5 A / 1 mm <sup>2</sup>	   	35
	SR215xxVBNC *(AST215)	 300 V / 10 A / 28–16 250 V / 17.5 A / 1.5 mm <sup>2</sup>	     	35
	SR215xxVBPC	 300 V / 10 A / 28–16 250 V / 17.5 A / 1.5 mm <sup>2</sup>	     	36
	ST105xxVDNN *(AST105)	 300 V / 15 A / 28–12 250 V / 13.5 A / 1 mm <sup>2</sup>	   	36
	ST125xxVDNN *(AST125)	 300 V / 15 A / 28–12 250 V / 13.5 A / 1 mm <sup>2</sup>	   	37
	ST145xxVDNN *(AST145)	 300 V / 17 A / 28–14 450 V / 17.5 A / 1.5 mm <sup>2</sup>	   	37

 Spring clamp terminal block

 Solderable

 Designed for THR

 Wire entry 90°

 Wire protector

 Wire entry 0°

 Approval pending

 Lift system

 Pluggable

 Designed for SMT

 Centerline

 Diagonal wire entry



 Tape & Reel possible

IMAGE	PART NUMBER	PROPERTIES	FEATURE	PAGE NUMBER MAIN CATALOG
	ST176xxLDNN *(AST176)	 300 V / 15 A / 28–12  250 V / 13.5 A / 1 mm <sup>2</sup>	   	38
	ST186xxLDNN *(AST186)	 300 V / 15 A / 28–12  250 V / 13.5 A / 1 mm <sup>2</sup>	   	38
	ST027xxHDNC *(AST027)	 600 V / 13 A / 28–14  750 V / 13.5 A / 1 mm <sup>2</sup>	   	39
	ST057xxHBNC *(AST057)	 300 V / 17 A / 28–12  250 V / 20 A / 2.5 mm <sup>2</sup>	   	40
	ST047xxDDNC *(AST047)	 600 V / 13 A / 28–14  750 V / 13.5 A / 1 mm <sup>2</sup>	   	40
	SR207xxDBVN	 300 V / 16 A / 20–14  250 V / 24 A / 2.5 mm <sup>2</sup>	    	-
	ST137xxDDNC *(AST137)	 300 V / 13 A / 28–14  750 V / 24 A / 2.5 mm <sup>2</sup>	   	41
	ST177xxLDNN *(AST177)	 750 V / 15 A / 28–12  250 V / 13.5 A / 1 mm <sup>2</sup>	   	41
	ST187xxLDNN *(AST187)	 750 V / 15 A / 28–12  250 V / 13.5 A / 1 mm <sup>2</sup>	   	42
	ST098xxHDNN *(AST098)	 600 V / 15 A / 28–12  250 V / 13.5 A / 1 mm <sup>2</sup>	   	43
	ST178xxLDNN *(AST178)	 750 V / 15 A / 28–12  250 V / 13.5 A / 1 mm <sup>2</sup>	   	43

## Products

IMAGE	PART NUMBER	PROPERTIES	FEATURE	PAGE NUMBER MAIN CATALOG
	ST188xxLDNN *(AST188)	 750 V / 15 A / 28–12  250 V / 13.5 A / 1 mm <sup>2</sup>	    	44
	ST108xxVDNN *(AST108)	 600 V / 15 A / 28–12  250 V / 13.5 A / 1 mm <sup>2</sup>	    	44
	ST128xxVDNN *(AST128)	 600 V / 15 A / 28–12  250 V / 13.5 A / 1 mm <sup>2</sup>	    	45
	ST029xxHDNC	 300 V / 13 A / 28–14  800 V / 13.5 A / 1 mm <sup>2</sup>	    	-
	ST059xxHBNC *(AST059)	 600 V / 12 A / 28–12  250 V / 10 A / 2.5 mm <sup>2</sup>	    	46
	ST139xxDDNC *(AST139)	 300 V / 13 A / 28–14  800 V / 24 A / 2.5 mm <sup>2</sup>	    	46
	SP051xxVGNN *(ASP051)	 150 V / 5 A / 28–20  80 V / 6 A / 0.08–0.5 mm <sup>2</sup>	    	47
	SP043xxVBNN *(ASP043)	 150 V / 10 A / 28–16  130 V / 10 A / 0.08–1.5 mm <sup>2</sup>	    	48
	SW063xxVBNN	 150 V / 8 A / 28–16  130 V / 8 A / 0.08–1.5 mm <sup>2</sup>	    	48
	SP063xxVGNN *(ASP063)	 150 V / 8 A / 28–16  130 V / 8 A / 0.08–1.5 mm <sup>2</sup>	    	49
	SP063xxVGNF *(ASP083)	 150 V / 8 A / 28–16  130 V / 8 A / 0.08–1.5 mm <sup>2</sup>	    	49

 Spring clamp terminal block

 Solderable

 Designed for THR

 Wire entry 90°

 Wire protector

 Wire entry 0°

 Approval pending

 Lift system

 Pluggable

 Designed for SMT

 Centerline

 Diagonal wire entry



 Tape & Reel possible

IMAGE	PART NUMBER	PROPERTIES	FEATURE	PAGE NUMBER MAIN CATALOG
	SP044xxVBNN *(ASP044)	 150 V / 10 A  130 V / 10 A / 0.08–1.5 mm <sup>2</sup>	   	50
	SP064xxVGNN *(ASP064)	 150 V / 8 A / 28–16  130 V / 9 A / 0.08–1.5 mm <sup>2</sup>	   	50
	SP064xxVGNF *(AP084)	 150 V / 8 A / 28–16  130 V / 9 A / 0.08–1.5 mm <sup>2</sup>	   	51
	SP025xxHDNC *(ASP025)	 300 V / 8 A / 28–16  250 V / 10 A / 0.08–1.5 mm <sup>2</sup>	   	52
	SP145xxHBNC *(ASP145)	 300 V / 6 A / 28–16  250 V / 13.5 A / 0.08–1.5 mm <sup>2</sup>	   	52
	SP145xxHBVC	 300 V / 6 A / 28–16  250 V / 13.5 A / 0.08–1.5 mm <sup>2</sup>	   	-
	SP145xxHBPC	 300 V / 6 A / 28–16  250 V / 13.5 A / 0.08–1.5 mm <sup>2</sup>	   	-
	SP155xxHBNC *(ASP155)	 300 V / 6 A / 28–16  250 V / 13.5 A / 0.08–1.5 mm <sup>2</sup>	   	53
	SP155xxHBPC	 300 V / 6 A / 28–16  250 V / 13.5 A / 0.08–1.5 mm <sup>2</sup>	   	-
	SP045xxVBNC *(ASP045)	 300 V / 10 A / 28–16  250 V / 10 A / 0.08–1.5 mm <sup>2</sup>	   	53
	SP065xxVBNC	 300 V / 12 A / 28–12  250 V / 12 A / 0.08–2.5 mm <sup>2</sup>	   	54

## Products

IMAGE	PART NUMBER	PROPERTIES	FEATURE	PAGE NUMBER MAIN CATALOG
	SP065xxVBPC	<b>UL</b> 300 V / 12 A / 28–12 250 V / 12 A / 0.08–2.5 mm <sup>2</sup>	   	54
	SP065xxVBNF	<b>UL</b> 300 V / 12 A / 28–12 250 V / 12 A / 0.08–2.5 mm <sup>2</sup>	   	55
	SP065xxVBPF	<b>UL</b> 300 V / 12 A / 28–12 250 V / 12 A / 0.08–2.5 mm <sup>2</sup>	   	55
	SP995xxVBNC	<b>UL</b> 250 V / 10.5 A / 24–14 250 V / 10.5 A / 0.2–2.5 mm <sup>2</sup>	   	56
	SP046xxVBNC *(ASP046)	<b>UL</b> 300 V / 10 A / 28–16 250 V / 10 A / 0.08–1 mm <sup>2</sup>	   	57
	SP066xxVBNC	<b>UL</b> 300 V / 12 A / 28–12 250 V / 12 A / 0.08–2.5 mm <sup>2</sup>	   	57
	SP066xxVBPC	<b>UL</b> 300 V / 12 A / 28–12 250 V / 12 A / 0.08–2.5 mm <sup>2</sup>	   	58
	SP066xxVBNF	<b>UL</b> 300 V / 12 A / 28–12 250 V / 12 A / 0.08–2.5 mm <sup>2</sup>	   	58
	SP066xxVBPF	<b>UL</b> 300 V / 12 A / 28–12 250 V / 12 A / 0.08–2.5 mm <sup>2</sup>	   	59
	SP049xxVBNC *(ASP049)	<b>UL</b> 300 V / 8 A / 28–16 630 V / 10 A / 0.08–1 mm <sup>2</sup>	   	60
	SP129xxVBNF *(ASP129)	<b>UL</b> 300 V / 10 A / 28–12 630 V / 12 A / 0.08–2.5 mm <sup>2</sup>	   	60

 Spring clamp terminal block

 Solderable

 Designed for THR

 Wire entry 90°

 Wire protector

 Wire entry 0°

 **UL** Approval pending

 Lift system

 Pluggable

 Designed for SMT

 Centerline

 Diagonal wire entry





















 Tape & Reel possible

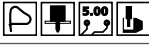

IMAGE	PART NUMBER	PROPERTIES	FEATURE	PAGE NUMBER MAIN CATALOG
	SP04AxxVBNC *(ASP04A)	10 A / 0.08–1.5 mm <sup>2</sup>		61
	SC303xxHBNN	 150 V / 4 A / 28–16  130 V / 4 A / 0.08–1.5 mm <sup>2</sup>		-
	SL303xxHBNN	 150 V / 4 A / 28–16  130 V / 4 A / 0.08–1.5 mm <sup>2</sup>		-
	SC305xxHBNN	 250 V / 4 A / 28–16  250 V / 4 A / 0.08–1.5 mm <sup>2</sup>		62
	SL305xxHBNN	 250 V / 4 A / 28–16  250 V / 4 A / 0.08–1.5 mm <sup>2</sup>		62
	SM99S	 9 A / 24–16  9 A / 0.2–0.75 mm <sup>2</sup>		63
	SR99S	 9 A / 24–16  9 A / 0.2–0.75 mm <sup>2</sup>		63
	SM01W	13 A / 0.1–0.75 mm <sup>2</sup>		64
	SM01Y	13 A / 0.75–1.5 mm <sup>2</sup>		64
	SM02V	13 A / 0.75–1.5 mm <sup>2</sup>		-

## Spring Clamp Terminal Blocks

The product family consists of terminal blocks that are based on a spring clamp connection. By spring clamp connection, we mean an electrical connection that is created by clamping an individual conductor using a spring. It is suitable for solid and stranded wires from 28 to 12 AWG.

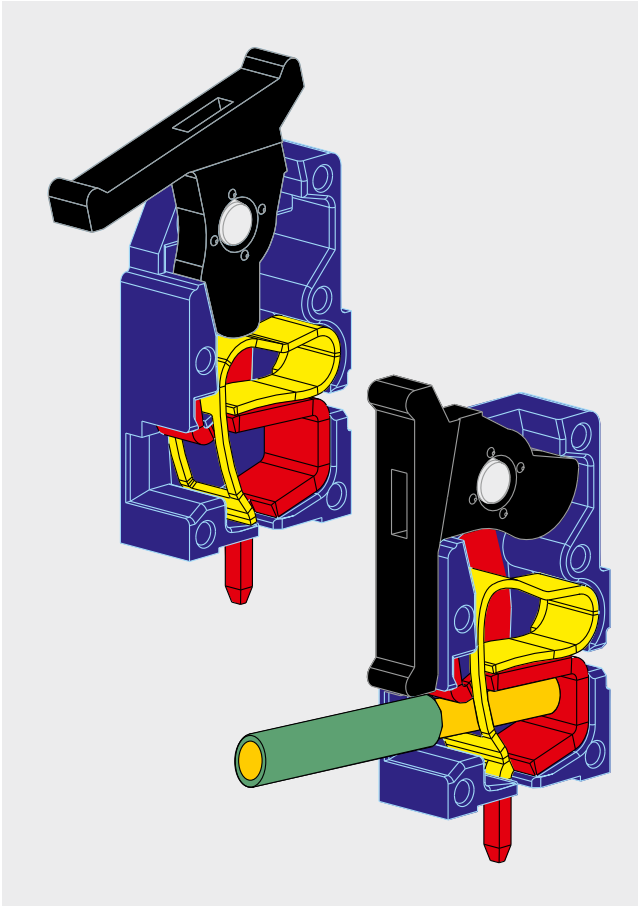

### Spring clamp terminal block with cage clamp (with and without eccentric lever)

- > with eccentric lever open terminal is ready for wire sizes
- > with eccentric lever tool-less connection of the conductors
- > very short assembly times
- > the closed power system inside the terminal block prevents pressure from being applied onto the circuit board at the time of connection
- > gas-proof connection at the terminal point
- > different colors available
- > the spring adapts automatically to changes in conductor

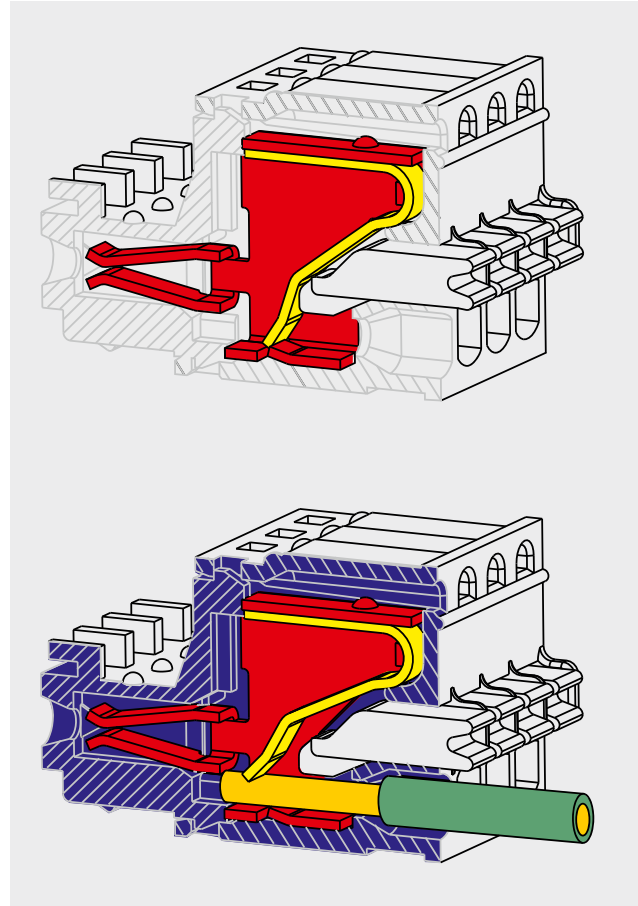

### Spring clamp terminal block with push-buttons

- > solid wires can be connected by simply inserting without actuation of the button (push-in technology)
- > stranded wires and thin solid wires are connected using a standard screwdriver
- > short assembly times
- > gas-proof connection at the terminal point
- > different colors available
- > the spring adapts automatically to changes in conductor sizes

## Reflow-compatible components

METZ CONNECT offers a wide range of spring clamp terminal blocks in reflow-compatible designs. The demand for reflow-compatible components is constantly growing thanks to increasing degrees of automation in the production processes.



## Printing Options

We offer individual printing options for your terminal blocks. Figures and/or symbols in different orientations depending on the technical feasibility. Inkjet Printing, Pad Printing, and Hot Stamp Printing are available. Design your individual terminal blocks with us.

## Color Options

You can order our terminal blocks in a variety of colors. In some cases we can offer color coding for each individual pole. This is helpful for either as an additional coding option or to enhance the overall "look" of your device. We would be pleased to advise you on the possible combinations.

METZ CONNECT GmbH is member of the following organizations and associations.



### METZ CONNECT GmbH

Im Tal 2  
78176 Blumberg  
Germany

Phone +49 7702 533-0  
Fax +49 7702 533-189

### METZ CONNECT France SAS

28, Rue Schweighaeuser  
67000 Strasbourg  
France

Phone +33 3886 17073  
Fax +33 3886 19473

### METZ CONNECT Zhongshan Ltd.

Ping Chang Road  
Ping Pu Industrial Park  
Sanxiang Town  
Zhongshan City, 528463  
Guangdong Province  
China

Phone +86 760 86365 055  
Fax +86 760 86365 050

### METZ CONNECT Asia Pacific Ltd.

Suite 1803, 18/F  
Chinachem Hollywood Centre,  
1 Hollywood Road, Central  
Hong Kong

Phone +852 26 027 300  
Fax +852 27 257 522

### METZ CONNECT USA Inc.

200 Tornillo Way  
Tinton Falls, NJ 07712  
USA

Phone +1-732-389-1300  
Fax +1-732-389-9066

info@metzconnectusa.com  
www.metz-connect.com

